

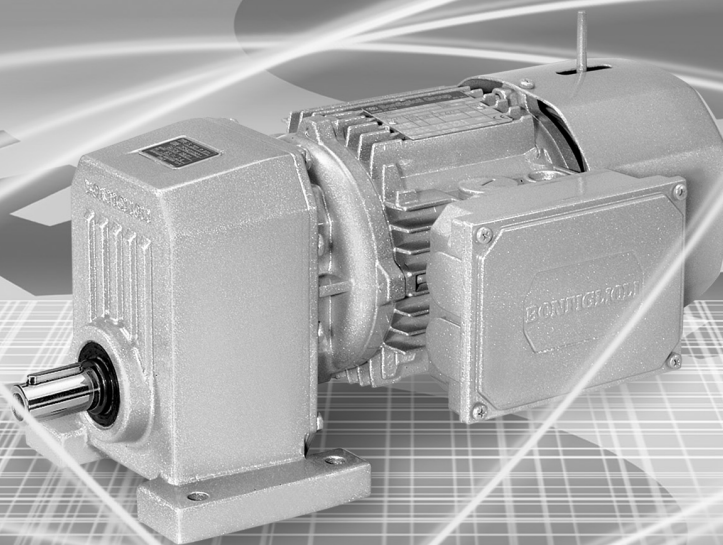











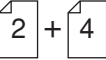

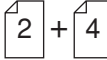
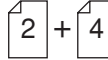
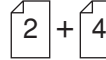

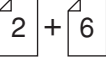
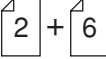
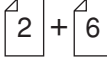
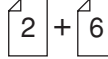
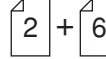
*Lista parti di ricambio - Spare parts list - Ersatzteilliste
Liste des pieces detachees - Lista de partes de recambio*

S

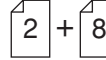

Quadro d'unione delle tavole parti di ricambio
Index of spare parts tables
Inhaltsverzeichnis Ersatzteillisten
Index des tables de pièces de rechange
Índice de la tabla de partes de recambio

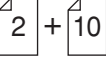
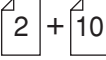
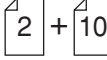
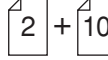
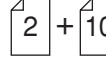
INPUT	S 10 1	S 20 1	S 30 1	S 40 1	S 50 1
 S_					
 P63 ... P132					
 P160 ... P180					
 HS					

S 10

S 20

S 30







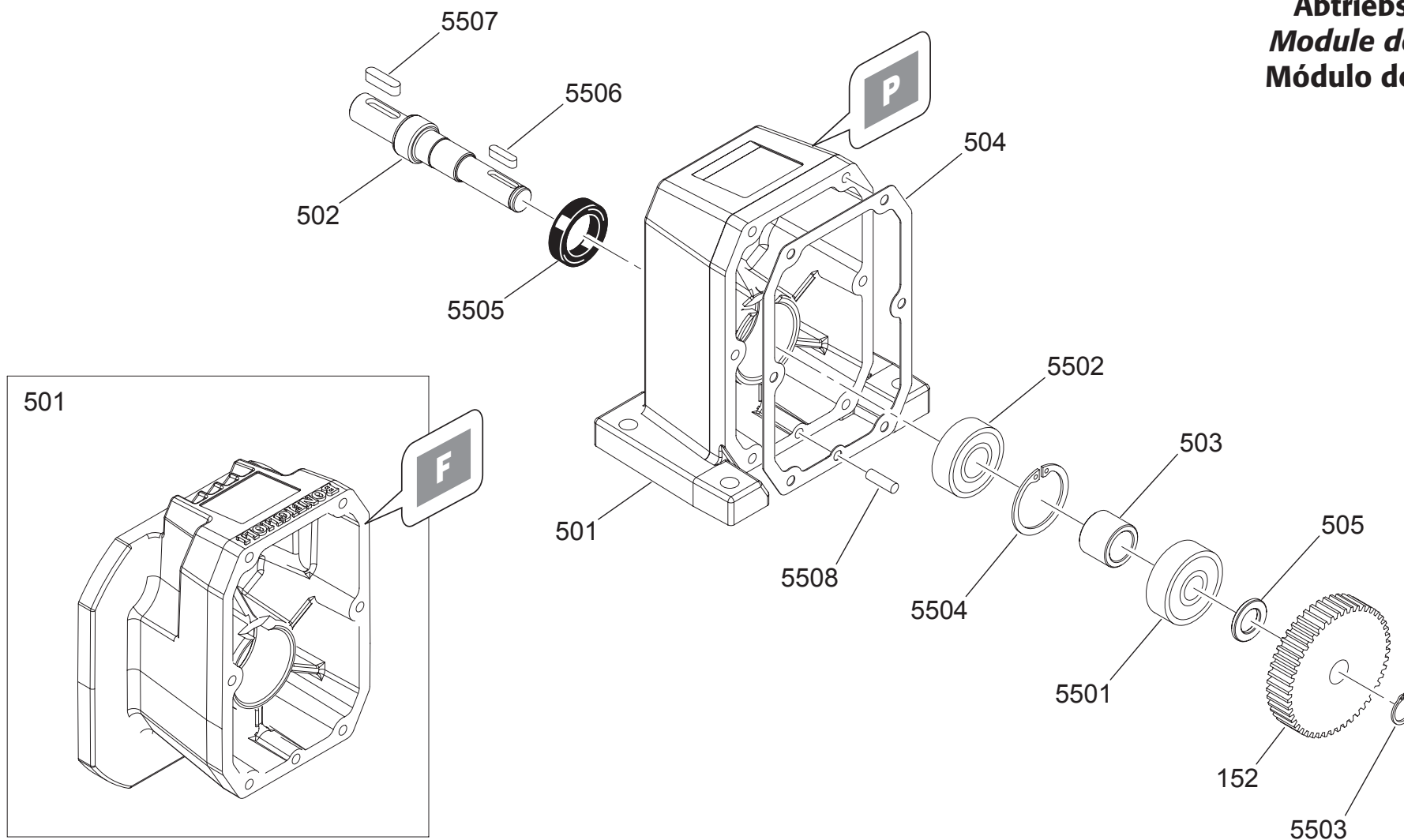

S 40

S 50

Modulo uscita
Output sub-assembly
Abtriebseinheit
Module de sortie
Módulo de salida







Pos.	Descrizione	Description	Benennung	Description	Descripción
152	Corona	Gear	Zahnrad	Couronne	Corona
501	Cassa	Housing	Gehäuse	Carter	Caja
502	Albero lento	Output shaft	Abtriebswelle	Arbre de sortie	Eje de salida
503	Distanziale	Spacer ring	Distanzring	Entretoise	Distanciador
504	Guarnizione	Gasket	Dichtung	Joint plat	Junta

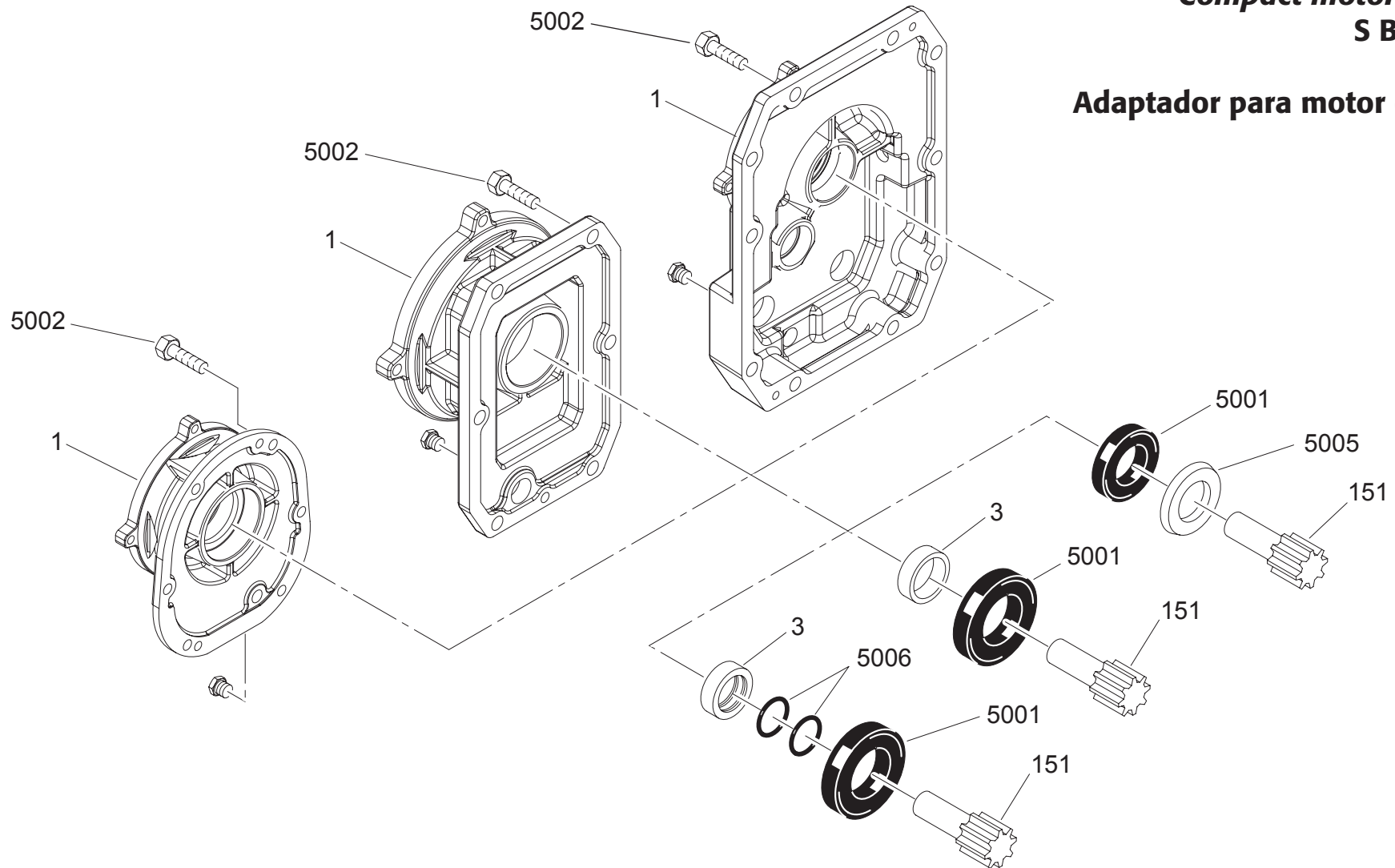

									
	5501	5502	5504	5503	5508	5506	5507	505	5505
S 10	6301	6202	DI 35	DE 12	ø5x16	4x4x16 C	5x5x20 A	12.2x16.8x0.5	20x30x7 DL
S 20	6303	6303	DI 47	DE 15	ø5x16	5x5x17 C	6x6x35 A	26.9x15.5x3	25x42x7 DL
S 30	6304	6304	DI 52	DE 17	ø6x16	5x5x19 C	8x7x40 A	17.2x27.8x0.5	30x42x7 DL
S 40	6305	6305	DI 62	DE 20	ø6x16	6x6x25 C	8x7x50 A	20.5x34.8x1	35x52x7 DL
S 50	6307	6307	DI 80	DE 25	ø6x16	8x7x25 C	10x8x60 A	25.2x48.8x1	50x72x8 DL
		V3 - V6							

Interfaccia per motore compatto
Compact motor interface
S Baueinheit
Module S
Adaptador para motor compacto



Pos.	Descrizione	Description	Benennung	Description	Descripción
1	Coperchio	Cover	Deckel	Couvercle	Tapa
3	Boccola	Bushing	Buchse	Douille	Casquillo
151	Pignone	Pinion gear	Ritzel	Pignon	Piñon



	 5001				 5005			 OR 5006	
	S 10	S 20	S 30	S 40 - S 50	S 10 - S 20	S 30	S 40 - S 50	S 20 - S 30	S 40 - S 50
S05	20x35x7 L	20x35x7 L			20x35x4				
S1	20x35x7 L 25x35x7 L	20x35x7 L 25x35x7 L	20x35x7 L 25x35x7 L	20x35x7 L 25x35x7 L	20x35x4	20x35x4	20x35x4		
S2	35x55x8 L	35x55x8 L 42x55x8 L	35x55x8 L 42x55x8 L	35x55x8 L 42x55x8 L	35x52x4.5	35x52x4.5	35x52x4.5		
S3	35x62x7 L	35x62x7 L 48x62x8 L	35x62x7 L 48x62x8 L	35x62x7 L 48x62x8 L	35x52x4.5	35x52x4.5	35x52x4.5	4137	4137
S4				45x85x10 L 65x85x10 L			45x62x4.5		149

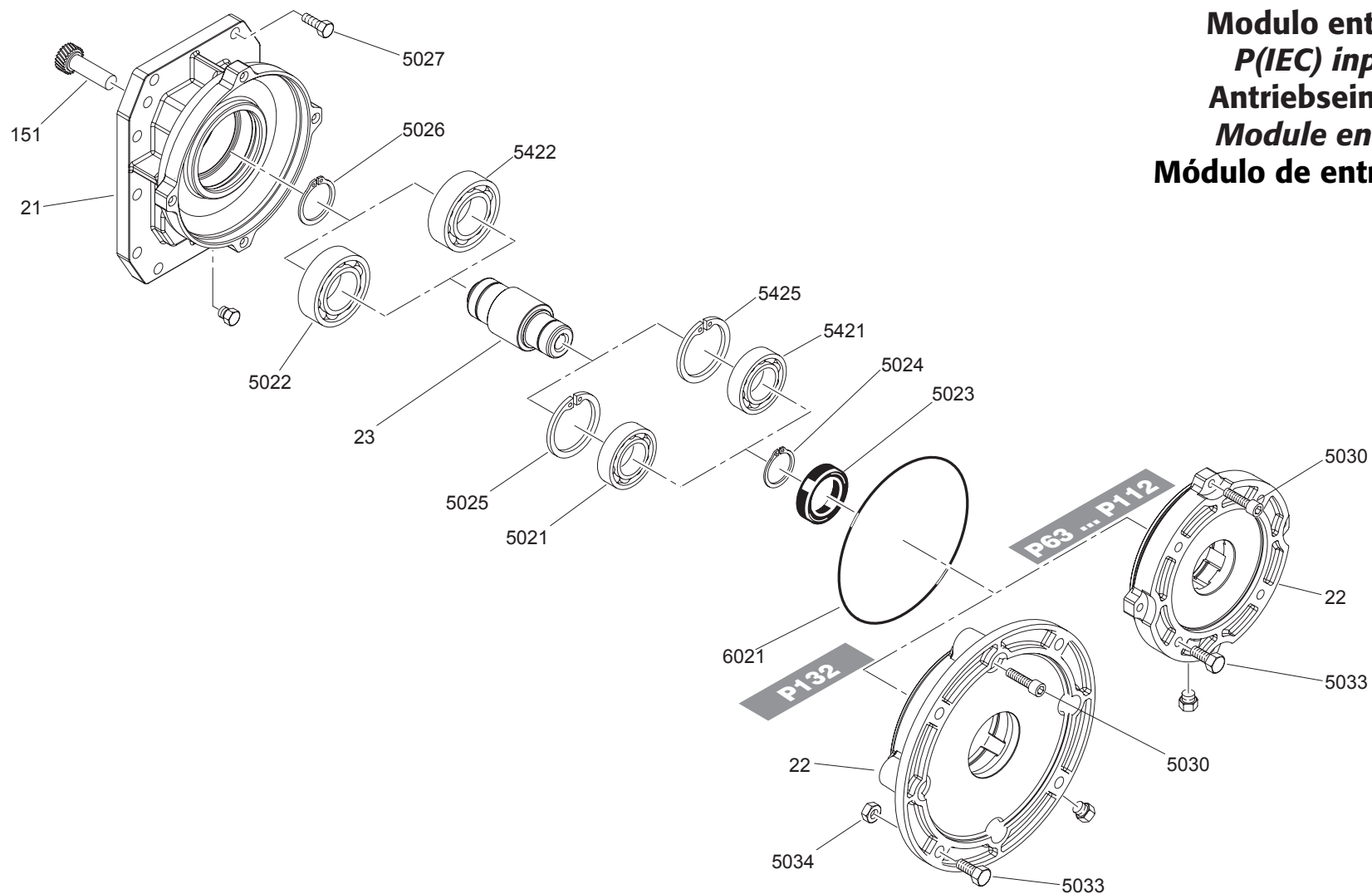



	 5002				
	S 10	S 20	S 30	S 40	S 50
S05	M6x18 M6x20 M6x22	M6x20			
S1	M6x20 M6x22	M6x16 M6x18 M6x20 M6x22	M8x25	M8x25	M10x25 M10x30
S2	M6x20 M6x22	M6x20 M6x22	M8x25	M8x20 M8x25	M10x25 M10x30
S3	M6x20 M6x22	M6x20 M6x22	M8x25	M8x20 M8x25	M10x25 M10x30
S4				M8x20 M8x25	M10x25 M10x30



Modulo entrata P(IEC)
P(IEC) input module
Antriebseinheit P(IEC)
Module entree P(IEC)
Módulo de entrada P(IEC)

Pos.	Descrizione	Description	Benennung	Description	Descripción
21	Coperchio	Cover	Deckel	Couvercle	Tapa
22	Flangia	Flange	Flansch	Bride	Brida
23	Albero veloce	Input shaft	Antriebswelle	Arbre rapide	eje de salida
151	Pignone	Pinion gear	Ritzel	Pignon	Piñon







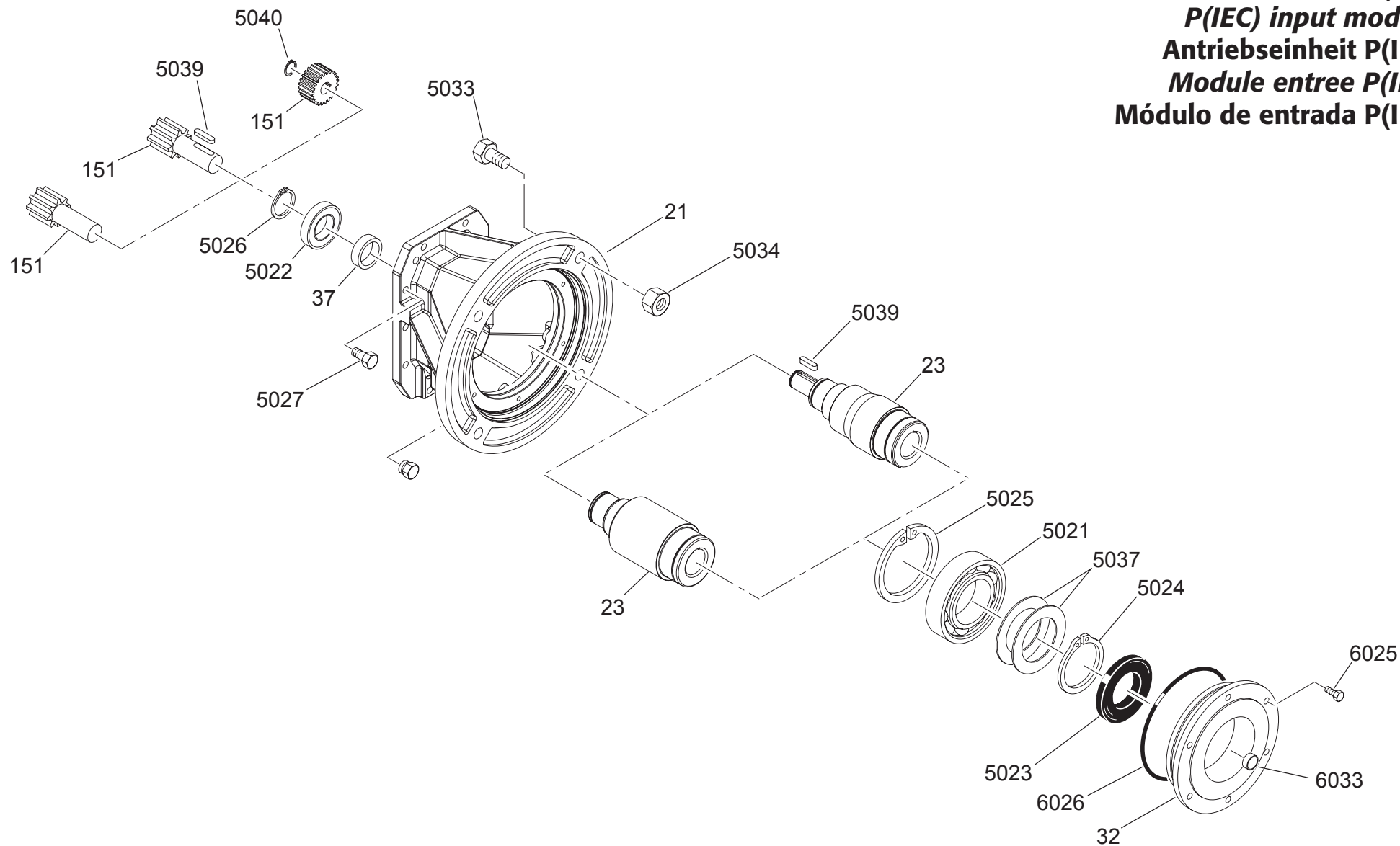







	 5027					5030	5033	 OR 6021		 5034
	S 10	S 20	S 30	S 40	S 50			S 10 ... S 30	S 40 - S 50	
P63	M6x20	M6x20 M6x22	M8x25	M8x20 M8x25	M10x25 M10x30	M5x20	M8x20	3475	3475	
P71	M6x20 M6x22	M6x20 M6x22	M8x25	M8x20 M8x25	M10x25 M10x30	M5x20	M8x20	3475	3475	
P80	M6x20 M6x22	M6x20 M6x22	M8x25	M8x20 M8x25	M10x25 M10x30	M6x25	M10x22	3575	3575	
P90	M6x20 M6x22	M6x20 M6x22	M8x25	M8x20 M8x25	M10x25 M10x30	M6x25	M10x22	3575	3575	
P100 P112	M6x20 M6x22	M6x20 M6x22	M8x25	M8x20 M8x25	M10x25 M10x30	M6x30	M12x30	3575	3800	
P132				M8x20 M8x25	M10x25 M10x30	M8x25	M12x50		3800	M12

	 5023	5021	 5022					5421	5422	 5024 5026		5025	 5425
			S 10	S 20	S 30	S 40	S 50			S 40 - S 50		S 40 - S 50	
P63	25x42x7 L	6005-2RS 6005-2RS WT	6006	6006 6006 2Z 6006-2RS WT	6006	6006	6006			25	30	47	
P71	25x42x7 L	6005-2RS 6005-2RS WT	6006	6006 6006 2Z 6006-2RS WT	6006	6006	6006			25	30	47	
P80	40x62x7 L	6008-2RS 6008-2RS WT	6007 6007 ETN9	6007 6007-2Z 6007-2RS WT 6007 ETN9	6007 6007 ETN9	6007 6007 ETN9	6007 6007 ETN9			40	35	68	
P90	40x62x7 L	6008-2RS 6008-2RS WT	6007 6007 ETN9	6007 6007-2Z 6007-2RS WT 6007 ETN9	6007 6007 ETN9	6007 6007 ETN9	6007 6007 ETN9			40	35	68	
P100 P112	45x72x8 L	6009-2RS 6009-2RS WT 6012-2RS	6007 ETN9	6007 ETN9 6007 6007-2Z 6007-2RS WT	6007 ETN9	6209	6209			45	35	75	
P132	55x80x8 L	6012-2RS WT				6209	6209	6012-2RS	6209	60	45	95	95

Modulo entrata P(IEC)
P(IEC) input module
Antriebseinheit P(IEC)
Module entree P(IEC)
Módulo de entrada P(IEC)



Pos.	Descrizione	Description	Benennung	Description	Descripción
21	Coperchio	Cover	Deckel	Couvercle	Tapa
23	Albero veloce	Input shaft	Antriebswelle	Arbre rapide	eje de salida
32	Cappellotto per cuscinetto	Bearing holder	Deckel	Capuchon	Sombbrero para rodamiento
37	Distanziale	Spacer ring	Distanzring	Entretoise	Distanciador
151	Pignone	Pinion gear	Ritzel	Pignon	Piñon







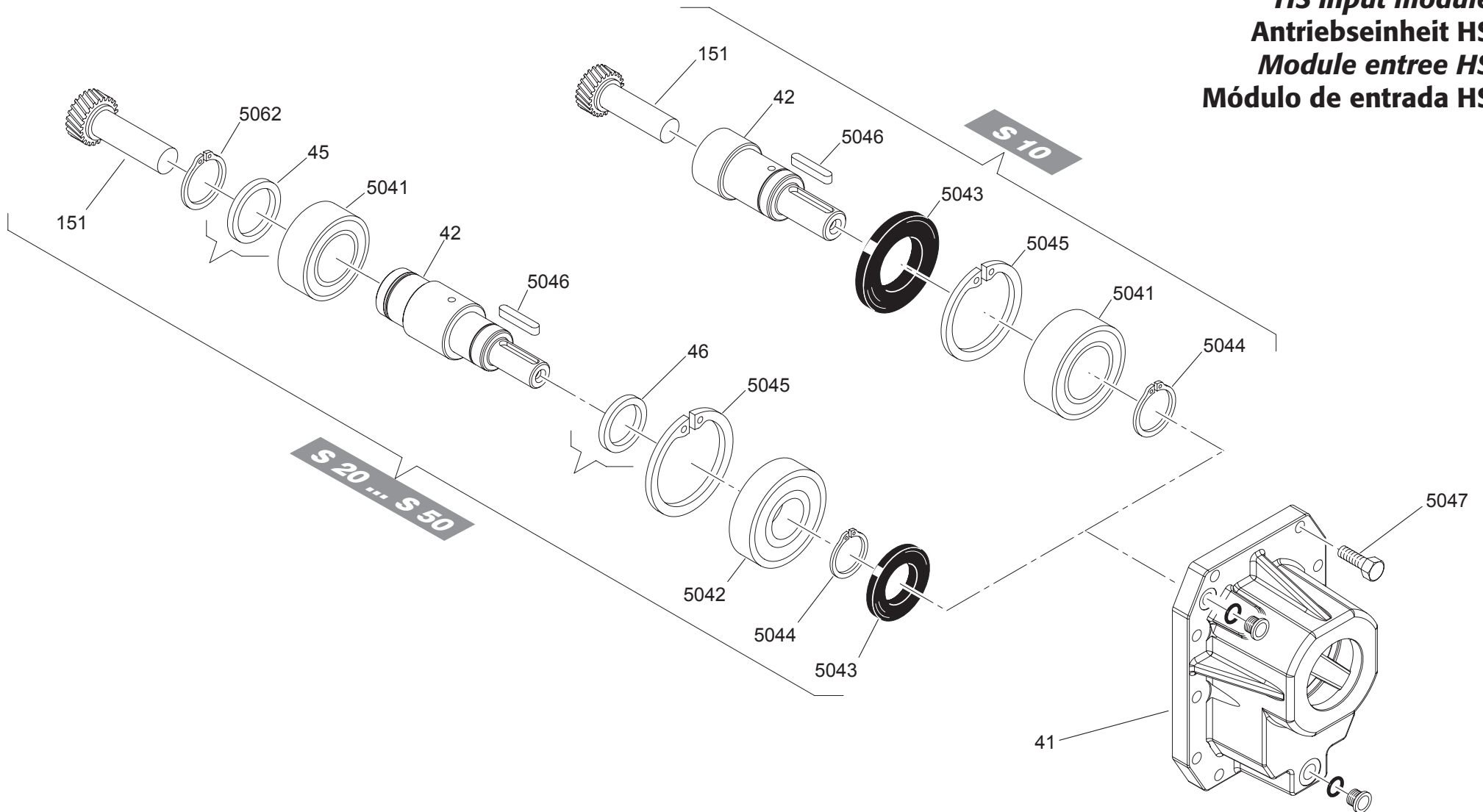

														 OR
	5021	5022	5039	5024	5026	5040	5025	5037	5034	5023	5027	5033	6025	6026
P160	6016 6016 2RS	NUP310 6310	8x7x45 A	80	50	30	140	80x100x2 P	M16	80x110x10 L	M10x30 M10x35 M10x45	M16x60	M8x25	3725
P180	6016 6016 2RS	NUP310 6310 6212	8x7x45 A 14x9x57 C	80	50 60	30 48	140	80x100x2 P	M16	80x110x10 L	M10x30 M10x35 M10x45	M16x60	M8x25	3725

S 10**S 20****S 30****S 40****S 50****HS**

Modulo entrata HS
HS input module
Antriebseinheit HS
Module entree HS
Módulo de entrada HS



Pos.	Descrizione	Description	Benennung	Description	Descripción
41	Coperchio	Cover	Deckel	Couvercle	Tapa
42	Albero veloce	Input shaft	Antriebswelle	Arbre rapide	eje de salida
45	Distanziale	Spacer ring	Distanzring	Entretoise	Distanciador
46	Distanziale	Spacer ring	Distanzring	Entretoise	Distanciador
151	Pignone	Pinion gear	Ritzel	Pignon	Piñon

								
	5041	5042	5043	5046	5044	5062	5045	5047
S 10	3206-2RS		35x62x7 L	5x5x35 A	30		62	T.E. M6x20 T.E. M6x22
S 20	6007	6206-2RS	30x52x7 L	6x6x35 A	30	35	62	T.E. M6x20 T.E. M6x22
S 30	6207	6306-2RS	30x52x7 L	6x6x35 A	30	35	72	T.E. M8x25 T.E. M8x30
S 40	6007	6206-2RS	30x52x7 DL	6x6x35 A	30	35	62	T.E. M8x25 T.E. M6x20
S 50	6210 i = 18.9...21.1 NUP 210 i = 2.6...16.6	6308-2RS	40x62x7 DL	8x7x45 a	40	50	90	T.E. M10x35

R0

	Descrizione	Description	Benennung	Description	Descripción

Questa pubblicazione annulla e sostituisce ogni precedente edizione o revisione. Ci riserviamo il diritto di apportare modifiche senza preavviso. E' vietata la riproduzione anche parziale senza autorizzazione.

This publication cancels and replaces any previous edition and revision. We reserve the right to implement modifications without notice. This catalogue cannot be reproduced, even partially, without prior consent.

Diese Veröffentlichung annulliert und ersetzt jeder hergehende Edition oder Revision. BONFIGLIOLI behält sich das Recht vor, Änderungen ohne vorherige Informationen durchzuführen.

Cette publication annule et remplace toutes les autres précédentes. Nous nous réservons le droit d'apporter toutes modifications à nos produits. La reproduction et la publication partielle ou totale de ce catalogue est interdite sans a autorisation.

Esta publicación anula y sustituye toda anterior edición o revisión. Nos reservamos el derecho de aportar modificaciones sin previo aviso. Se prohíbe la reproducción incluso parcial sin autorización.

Bonfiglioli Worldwide & BEST Partners

AUSTRALIA

BONFIGLIOLI TRANSMISSION (Aust) Pty Ltd.
48-50 Adderley St. (East) Auburn (Sydney) N.S.W. 2144
Tel. (+61) 2 8748 4400 - Fax (+61) 2 9748 8740
P.o. Box 6705 Silverwater NSW 1811
www.bonfiglioli.com.au - sales@bonfiglioli.com.au

AUSTRIA 

MOLL MOTOR GmbH
Industriestrasse 8 - 2000 Stockerau
Tel. (+43) 2266 63421-DW - Fax (+43) 6342 180 - Tlx 61 32 22 348 Molla
www.mollmotor.at - office@mollmotor.at

BELGIUM 

N.V. ESCO TRANSMISSION S.A.
Culliganlaan 3 - 1831 Machelem Diegem
Tel. 0032 2 7204880 - Fax 0032 2 7212827 - Tlx 21930 Escopo B
www.escotrans.be - info@escotrans.be

BRASIL 

ATI BRASIL
Rua Omlio Monteiro Soares, 260 - Vila Fanny - 81030-000
Tel. (+41) 334 2091 - Fax (+41) 332 8669
www.atibrasil.com.br - vendas@atibrasil.com.br

CANADA

BONFIGLIOLI CANADA INC.
2-7941 Jane Street - Concord, ONTARIO L4K 4L6
Tel. (+1) 905 7384466 - Fax (+1) 905 7389833
www.bonfigliolicanada.com - sales@bonfigliolicanada.com

CHINA

BONFIGLIOLI DRIVES (SHANGHAI) CO. LTD.
No. 8 Building, 98 Tian Ying Road - Qingpu District, Shanghai, PRC 201700
Tel. +86 21 69225500 - Fax +86 21 69225511
www.bonfiglioli.cn - linkn@bonfiglioli.com.cn

FRANCE

BONFIGLIOLI TRANSMISSIONS S.A.
14 Rue Eugène Pottier BP 19
Zone Industrielle de Moimont II - 95670 Marly la Ville
Tel. (+33) 1 34474510 - Fax (+33) 1 34688800
www.bonfiglioli.fr - btf@bonfiglioli.fr

GERMANY

BONFIGLIOLI DEUTSCHLAND GmbH
Hamburger Straße 18 - 41540 Dormagen
Tel. (+49) 2133 50260 - Fax (+49) 2133 502610
www.bonfiglioli.de - info@bonfiglioli.de

GREAT BRITAIN

BONFIGLIOLI UK Ltd
Unit 3 Colemeadow Road - North Moons Moat
Redditch, Worcestershire B98 9PB
Tel. (+44) 1527 65022 - Fax (+44) 1527 61995
www.bonfiglioli.co.uk - manwaha@bonfiglioli.com

BONFIGLIOLI (UK) LIMITED
5 Grosvenor Grange - Woolston - Warrington, Cheshire WA1 4SF
Tel. (+44) 1925 852667 - Fax (+44) 1925 852668
www.bonfiglioliuk.co.uk - sales@bonfiglioliuk.co.uk

GREECE

BONFIGLIOLI HELLAS S.A.
O.T. 48A T.O. 230 - C.P. 570 22 Industrial Area - Thessaloniki
Tel. (+30) 2310 796456 - Fax (+30) 2310 795903
www.bonfiglioli.gr - info@bonfiglioli.gr

HOLLAND 

ELSTO AANDRIJFTECHNIEK
Loosterweg, 7 - 2215 TL Voorhout
Tel. (+31) 252 219 123 - Fax (+31) 252 231 660
www.elsto.nl - imfo@elsto.nl

HUNGARY 

AGISYS AGITATORS & TRANSMISSIONS Ltd
2045 Törökbálint, Tö u.2. Hungary
Tel. +36 23 50 11 50 - Fax +36 23 50 11 59
www.agisys.hu - info@agisys.com

INDIA

BONFIGLIOLI TRANSMISSIONS PVT Ltd.
PLOT AC7-AC11 Sidco Industrial Estate
Thirumudivakkam - Chennai 600 044
Tel. +91(0)44 24781035 / 24781036 / 24781037
Fax +91(0)44 24780091 / 24781904
www.bonfiglioli.co.in - bonfig@vsnl.com

ITALY

A.T.I. di Morganti E. C. sas 
Via Pistoiese 219 - 50047 Prato (PO)
Tel. 0574/6961 - Fax 0574/790996
www.atimorganti.it - ati.morganti@texnet.it

BONETTI LUIGI SRL 
Strada Padana Superiore verso VR n.7 - 36100 Vicenza (VI)
Tel. 0444/563120 - Fax 0444/961979
www.bonettimotoriduttori.com - bonetti.luigi@libero.it

CASA DEL CUSCINETTO SAS di Castignoli e C. 
Strada Val Nure 18/a - 29100 Piacenza (PC)
Tel. 0523/755518 - 0523/756315 - Fax 0523/457804
www.casadelcuscinetto.net - antonio@casadelcuscinetto.net

CENTO TRASMISSIONI SRL 
Via Friuli 23 - 40060 Osteria Grande (BO)
Tel. 051/6958222 - Fax 051/6958253
www.centotrasmissioni.com - cento@centotrasmissioni.com

CONTASTA COMPONENTI SRL 
di Franca Di Clemente e Figli
Via Po 65/67 - Zona Comm. 66020 S. Giovanni Teatino (CH)
Tel. 085/4462696 - Fax 085/4461754
www.grupppofit.it - grupppofit@grupppofit.it

D.L. di Danielli B e Lolli G. SRL 
Via Fucini 2 - 40132 Bologna
Tel. 051/6177611 - Fax 051/6177630
www.daniellielli.it - info@daniellielli.it

EGA TECNIC SRL 
Via Maccani 171/2 - 38100 Trento
Tel. 0461 822176 - Fax 0461 821643
www.egatecnic.it - info@egatecnic.it

FIMU S.R.L. 
Via Artigianato - 25128 Savigliano (CN)
Tel. 0172/713542 - Fax 0172/715489
www.fimusrl.com - fimu@fimusrl.com

FITMA S.R.L. 
Viale del Commercio 10 - 37042 Caldiero (VR)
Tel. 045/6132511 - Fax 045/6150270
www.fitma.it - fitma@fitma.it

F.M.I. FRANCESCHI S.R.L. 
Strada Baganzola 28/a - 43100 Parma
Tel. 0521/992200 - Fax 0521/987303
www.fmparma.it - fmi@fmparma.it

INDUSTRIAL FURNITURE MORO SNC 
Via dei Da Prata 34 - 31100 Treviso
Tel. 0422 428835 - Fax 0422/428830
www.morotreviso.com - info@morotreviso.com

MICAR Snc di Sandro Arminio e C. 
Via Rosso di S. Secondo, 15 - 20134 Milano
Tel. 02/7491091 - Fax 02/70126372
www.micar.it - info@micar.it

MINETTI SPA FILIALE DI BERGAMO 
Via Canovine, 14 - 24100 Bergamo
Tel. 035/327111 - Fax 035/316767
www.minettigroup.com - minettiberghamo@minettigroup.com

MINETTI SPA FILIALE DI BRESCIA 
Via G. di Vittorio, 38 - Z.I. - 25128 Brescia
Tel. 030/3582734 - Fax 030/3582760
www.minettigroup.com - minettibrescia@minettigroup.com

S.I.R.I. SRL 
Via Dell'Industria 9 - 04011 Aprilia (LT)
Tel. 06/9206291 - Fax 06/9258643
www.sirisrl.com - info@sirisrl.com

SAROK ITALIA SRL 
Via Valsugana, 4 - 22053 Lecco (CO)
Tel. 0341/357811 - Fax 0341/283096
www.sarok.it - sarokitalia@sarok.it

SAROK DUE SRL 
Via 1 Maggio 9/11 - 20028 S. Vittore Olona (MI)
Tel. 0331/423911 - Fax 0331/423942
www.sarok.it - sarok2@tin.it

T.I.M. Tecn.Ind. Modenesi 
Via Franz Leahr 25 - 41100 Modena
Tel. 059/282500 - Fax 059/282404
www.timmodena.com - timmodena@timmodena.com

TECHNOBI SRL 
Via Lazio, 65 - 20090 Buccinasco (MI)
Tel. 02/45712362 - Fax 02/45712219
www.technobi.it - technobi@libero.it

TECNICA INDUSTRIALE SRL 
S.P. 231 km 1 ex S.S.98 Km 80,176 - 70026 Modugno (BA)
Tel. 080/5367089 - 080/5367090 - Fax 080/5367091
www.tecnicaindustriale.it - info@tecnicaindustriale.it

TECNOFORNITURE SRL 
Via Pasubio 106 - 63037 Porto d'Ascoli (AP)
Tel. 0735/76171 - Fax 0735/655266
www.tecnoforniture.it - info@tecnoforniture.it

V.B. Moto Trasmissioni s.n.c. 
di Volpe E. E Bianchi P. E. C.
Via Enzo Ferrari 335 - 47037 Cesena (FO)
Tel. 0547/630610 - Fax 0547/630615
www.vbmototrasmissioni.it - info@vbmototrasmissioni.it

VENETA BEARINGS SRL 
Via Torino 15 - 35035 Mestrino (PD)
Tel. 049/9001944 - 049/9001549 - Fax 049/9001543
www.venetabearings.it - info@venetabearings.it

NEW ZEALAND 

SAECO BEARINGS TRANSMISSION
36 Hastie Avenue, MangerePo Box 22256, Otahuhu - Auckland
Tel. +64 9 634 7540 - Fax +64 9 634 7552
mark@saeco.co.nz

POLAND 

POLPACK Sp. z o.o. - Ul. Chrobrego 135/137 - 87100 Torun
Tel. 0048.56.6559235 - 6559236 - Fax 0048.56.6559238
www.polpack.com.pl - polpack@polpack.com.pl

RUSSIA 

FAM
57, Maly prospekt, V.O. - 199048, St. Petersburg
Tel. +7 812 3319333 - Fax +7 812 3271454
www.fam-drive.ru - info@fam-drive.ru

SPAIN

TECNOTRANS SABRE S.A.
Pol. Ind. Zona Franca sector C, calle F, nº6 08040 Barcelona
Tel. (+34) 93 4478400 - Fax (+34) 93 3360402
www.tecnotrans.com - tecnotrans@tecnotrans.com

SOUTH AFRICA

BONFIGLIOLI POWER TRANSMISSION Pty Ltd.
55 Galaxy Avenue, Linbro Business Park - Sandton
Tel. (+27) 11 608 2030 OR - Fax (+27) 11 608 2631
www.bonfiglioli.co.za - bonfigsales@bonfiglioli.co.za

SWEDEN

BONFIGLIOLI SKANDINAVIEN AB
Kontorsgatan - 234 34 Lomma
Tel. (+46) 40 412545 - Fax (+46) 40 414508
www.bonfiglioli.se - info@bonfiglioli.se

THAILAND 

K.P.T MACHINERY (1993) CO.LTD.
259/83 Soi Phiboonves, Sukhumvit 71 Rd. Phrakhanong-nur,
Wattana, Bangkok 10110
Tel. 0066.2.3913030/7111998
Fax 0066.2.7112852/3811308/3814905
www.kpt-group.com - sales@kpt-group.com

USA

BONFIGLIOLI USA INC
1000 Worldwide Boulevard - Hebron, KY 41048
Tel.: (+1) 859 334 3333 - Fax: (+1) 859 334 8888
www.bonfiglioliusa.com
industrialsales@bonfiglioliusa.com
mobilesales@bonfiglioliusa.com

VENEZUELA 

MAQUINARIA Y ACCESORIOS IND.-C.A.
Calle 3B - Edif. Comindu - Planta Baja - Local B
La Urbina - Caracas 1070
Tel. 0058.2.12.2413570 / 2425268 / 2418263
Fax 0058.2.12.2424552 - Tlx 24780 Maica V
www.maica-ve.com - maica@telcel.net.ve

HEADQUARTERS

BONFIGLIOLI RIDUTTORI S.p.A.
Via Giovanni XXIII, 7/A
40012 Lippo di Calderara di Reno
Bologna (ITALY)
Tel. (+39) 051 6473111
Fax (+39) 051 6473126
www.bonfiglioli.com
bonfiglioli@bonfiglioli.com

SPARE PARTS BONFIGLIOLI

B.R.T.
Via Castagnini, 2-4
Z.I. Bargellino - 40012
Calderara di Reno - Bologna (ITALY)
Tel. (+39) 051 727844
Fax (+39) 051 727066
www.brtonbonfiglioliricambi.it
brt@bonfiglioli.com

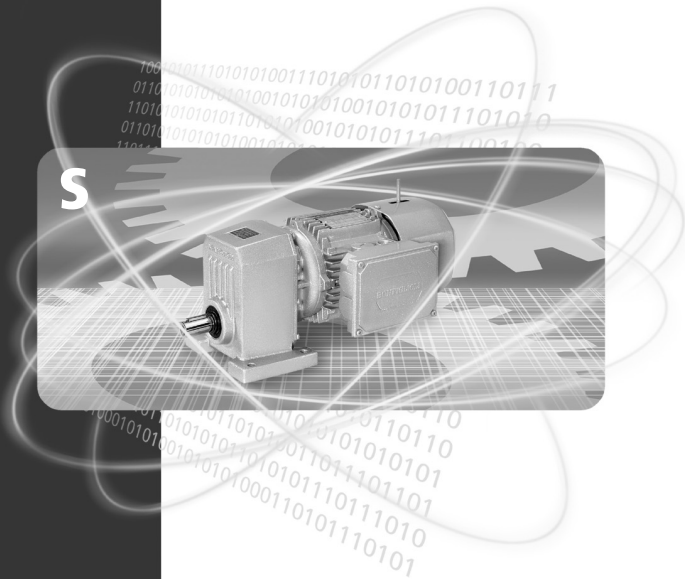

www.bonfiglioli.com

